

Every year the fire alarm system must be tested. The test should be carried out by a qualified person. The test should be carried out in accordance with the instructions in this manual.

Preparation: Before the test, the fire alarm system must be checked. The test should be carried out in accordance with the instructions in this manual.

When the test is carried out, the fire alarm system must be checked. The test should be carried out in accordance with the instructions in this manual.

Check the operation of the fire alarm system. The test should be carried out in accordance with the instructions in this manual.

External control (optional): Release control. Smoke control. Operation of the fire alarm system.

Smoke vent button: Press marked key in smoke vent button. The test should be carried out in accordance with the instructions in this manual.

Press marked key in smoke vent button. The test should be carried out in accordance with the instructions in this manual.

Emergency supply: Detach fuse. The test should be carried out in accordance with the instructions in this manual.

Green mains indication. The test should be carried out in accordance with the instructions in this manual.

Light. The test should be carried out in accordance with the instructions in this manual.

Light. The test should be carried out in accordance with the instructions in this manual.

Instruction for use



Smoke Vent System RZN 4102/08Kv2

installation

**Safety system protects human life and material assets!
Once a year functional testing by a specialist company, authorized by the manufacturer.**

Connection, mounting and functional testing by a specialist company authorized by the manufacturer.

Green control diodes in buttons must continuously lighten, otherwise see "fault finding".

Repair power failure at once. Emergency power supply for 72 hours.

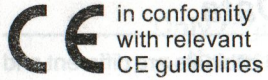

in conformity with relevant CE guidelines

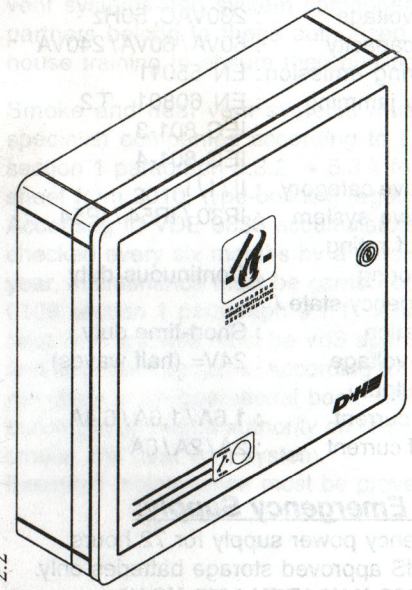

RZN 4102-K V2

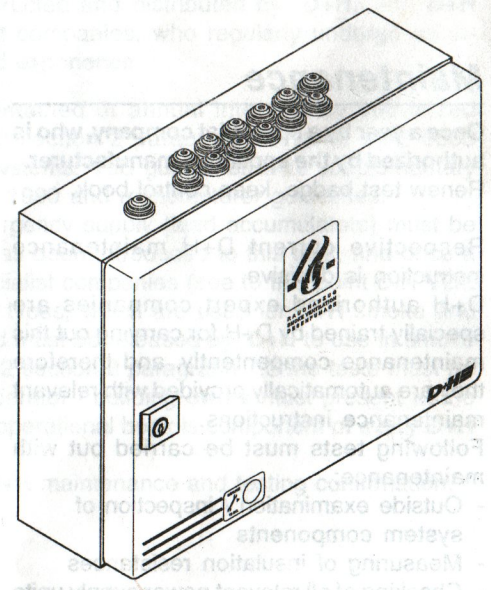

RZN 4102-KS V2

RZN 4108-K V2

99.820.86 Rev.: 2.2

Content

Guarantee	2
Maintenance	2
Technical data	2
Introduction	3
System overview	4
Mounting RZN 4102-K	5-6
View Motherboard RZN 4102-K	7
View Motherboard RZN 4108-K	8
Drives and smoke vent buttons	9
Wirung plan	10
Connection cable	11
Connection plans	12-14
Starting	15
Encode of line and group	16
Fault finding	17
Examination	18

Maintenance

Once a year by a specialist company, who is authorized by the appliance manufacturer.

Renew test badge, keep control book.

Respective current D+H maintenance instruction is decisive.

D+H authorized expert companies are specially trained by D+H for carrying out this maintenance competently, and therefore they are automatically provided with relevant maintenance instructions.

Following tests must be carried out with maintenance:

- Outside examination / inspection of system components
- Measuring of insulation resistances
- Checking of all relevant power supply units
- Functional testing of connected system components
- Record of competent carrying-out of maintenance, and designation according to directions

Guarantee

You will get **6 months** material-guarantee from date of delivery for all D+H products.

Our products come with **2 years** guarantee from date of verified handing over of the system up to maximal 3 years after date of delivery, when mounting and starting has been carried out by a D+H authorized **distributor**.

D+H works guarantee is expired, with connection of D+H components with external systems or with mixing of D+H products with parts of other manufacturers.

Technical Data

Some data of control cabinets are different and separated by oblique strokes.

Rated voltage	: 230VAC, 50Hz
Rated capacity	: 60VA / 60VA / 240VA
Interfering emission:	EN 55011
Res. to jamming	: EN 60801 T.2 IEC 801-3 IEC 801-4
Protective category	: II / I / I
Protective system	: IP30 / IP54 / IP54
Class of rating	
- Monitoring	: Continuous duty
- Emergency state / ventilation	: Short-time duty
Output voltage	: 24V= (half waves)
Safe output	
- rated current	: 1,6A / 1,6A / 6,4A
- Cutoff current	: 2A / 2A / 8A

24 V Emergency Supply:

Emergency power supply for 72 hours
Use VdS approved storage batteries only.

RZN 4102-K V2 / RZN 4102-KS V2:

2x 12V / 1,2 Ah \pm 0,2Ah

With connection of alarm devices:

2x 12V / 2,2 Ah \pm 0,3Ah

RZN 4108-K V2:

2x 12V / 7,0 Ah \pm 0,3Ah

Introduction

Smoke and heat vent systems (RWA's) are very important elements of structural preventive fire protection.

Smoke and heat vent systems are appliances of preventive fire protection. They fulfil important functions in case of fire: protection of human life by providing a smokeless layer, by which rescue routes are kept free for the fire-brigade. Consequential damages by conflagration gases are reduced, and considerable material assets are protected from destruction. Precondition for this is absolutely reliable functioning of the systems in case of fire. Only electrical specialist companies are authorized to install these systems, who have electrical specialist staff with relevant experiences in installing danger alarm systems or smoke and heat vent systems. Only these ones can take on responsibility for functioning, and can ensure product liability for the whole system (see product liability law BGBL.I S.2198 and BGB (bodily injury, compensation for damage)).

Therefore, regular maintenance and checking of functional readiness is imperative and has to be ensured. These standard requirements are demanded according to regulations of the DIN, of the Association of German Insurer against damage of property (VdS) and the respective local authorities. Recommended is, that maintenance work should be carried out by authorized specialist companies, only.

Only regular and professional maintenance warrants the necessary and permanent functional safety.

Only authorized specialist companies are allowed to install and maintain smoke and heat vent systems and system components, constructed and distributed by **D+H**. All **D+H** partners belong to these authorized specialist companies, who regularly undergo an in-house training to ensure their qualification and experience.

Smoke and heat vent systems must be maintained at annual intervals by authorized specialist companies according to DIN 18232 section 2 paragraph 7.2, and VDE 0833 section 1 paragraph 5.3.2 + 5.3.4 for alarm systems, VdS guidelines 3/93 supplementary sheet form 3010, type-building regulation May 1990 and manufacturer guidelines.

According to VDE 0833 accumulators for emergency supply (lead accumulators) must be checked every six months by a person, who has been introduced to this task, and once a year, maintenance must be carried out by specialist companies (see to this point DIN VDE 0108 section 1 paragraph 9.1.1). Accumulator types, which are used for **D+H** smoke and heat vent systems must be VdS approved, and must be released by **D+H** to use in smoke and heat vent systems. According to DIN 18232 section 2 paragraph 7.2 the tests must be put down in an operational book, which the operator / building owner must present to the building supervision authority on request. This operational book is component of every **D+H** smoke and heat vent system.

Executed maintenance must be proved by a **D+H** maintenance and testing confirmation.

Important Regulations

VDE* 0833 for alarm systems, VDE 0100 for electrical systems, DIN 18232 for smoke and heat vent systems, regulations of the local fire-brigade and of EVU (electrical supply company) for electrical mains have to be observed.

* VDE = Association of German Electro- technical Engineers.

System Overview

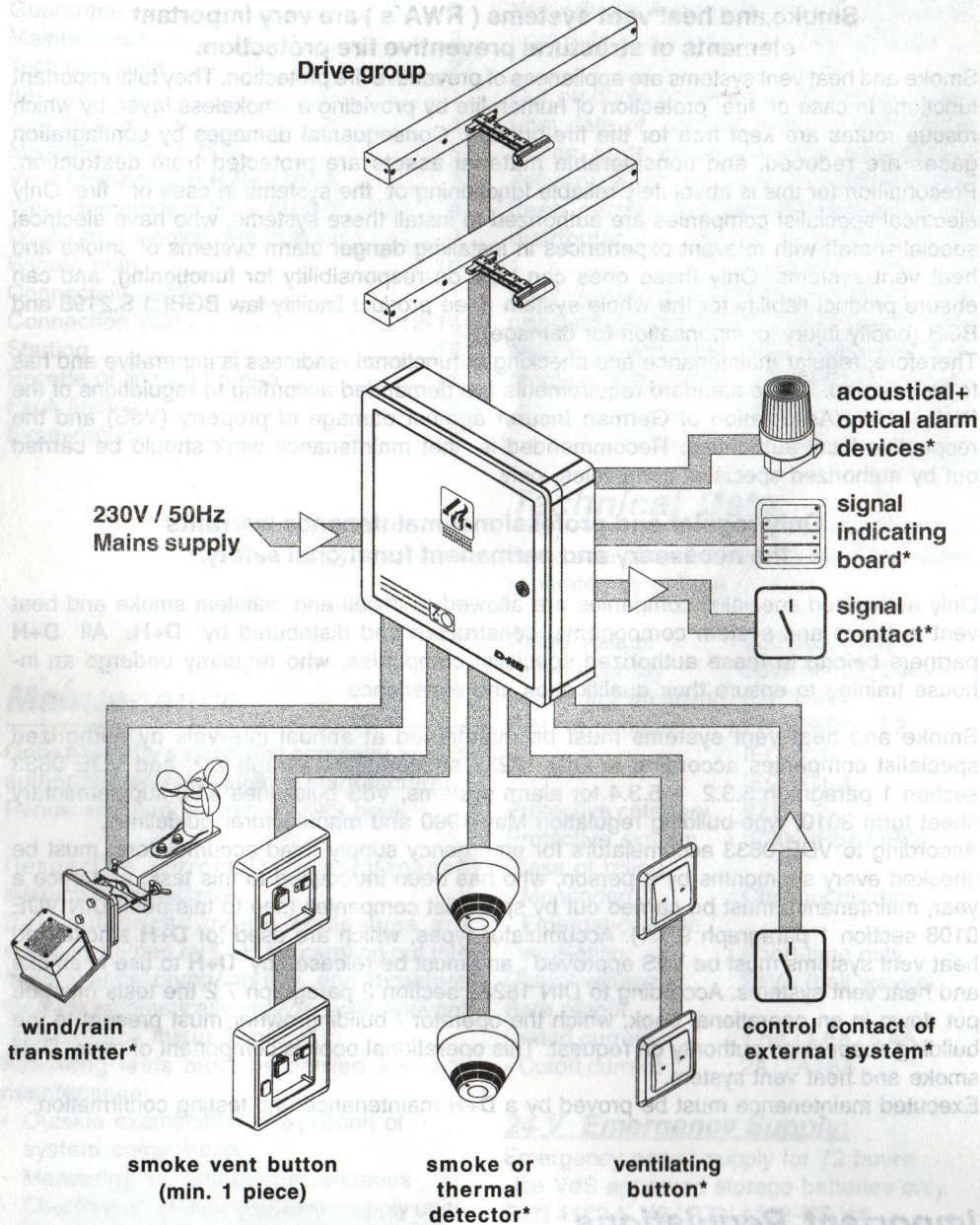

* optional function extension
(separate components. Retrofittable!)

Mounting Control Cabinet 1

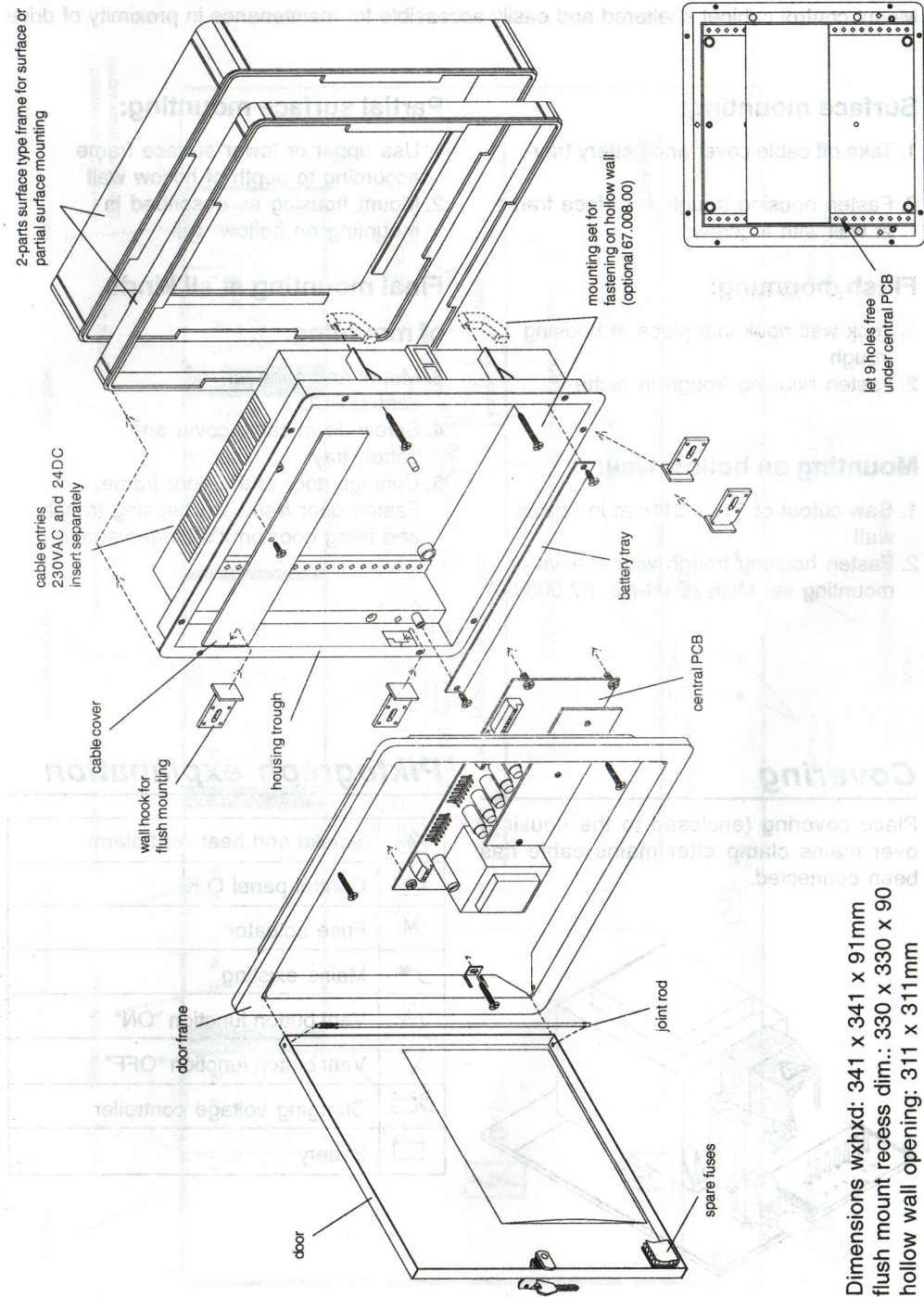

Dimensions wxhxd: 341 x 341 x 91mm
flush mount recess dim.: 330 x 330 x 90
hollow wall opening: 311 x 311mm

Mounting Control Cabinet 2

Mount control cabinet sheltered and easily accessible for maintenance in proximity of drive

Surface mounting:

1. Take off cable cover and battery tray
2. Fasten housing trough + surface frame at wall with 4 screws

Flush mounting:

1. Lock wall hook into place in housing trough
2. Fasten housing trough in niche

Mounting on hollow wall:

1. Saw cutout of 311 x 311mm in hollow wall
2. Fasten housing trough with screws or mounting set MHB (D+H-No: 67.008.00)

Partial surface mounting:

1. Use upper or lower surface frame according to depth of hollow wall
2. Mount housing as described in mounting on hollow wall

Final mounting at all kinds

of mounting:

3. Mount and connect central PCB
4. Screw down cable cover and battery tray
5. Unhinge door of the door frame, Fasten door frame on housing trough, and hang door on it's hinges again

Covering

Place covering (enclosed to the housing) over mains clamp after mains cable has been connected.

Piktograph explanation

	Smoke and heat vent alarm
	Control panel O.K.
	Fuse actuator
	Mains existing
	Vent button function "ON"
	Vent button function "OFF"
	Charging voltage controller
	Battery

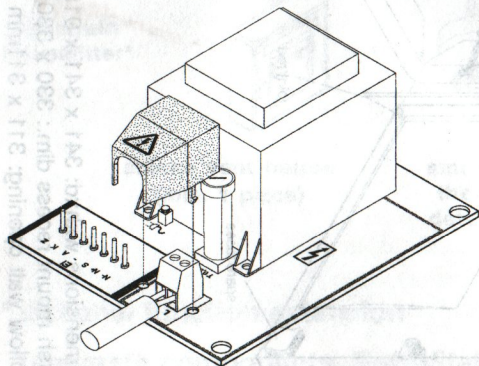

View Motherboard

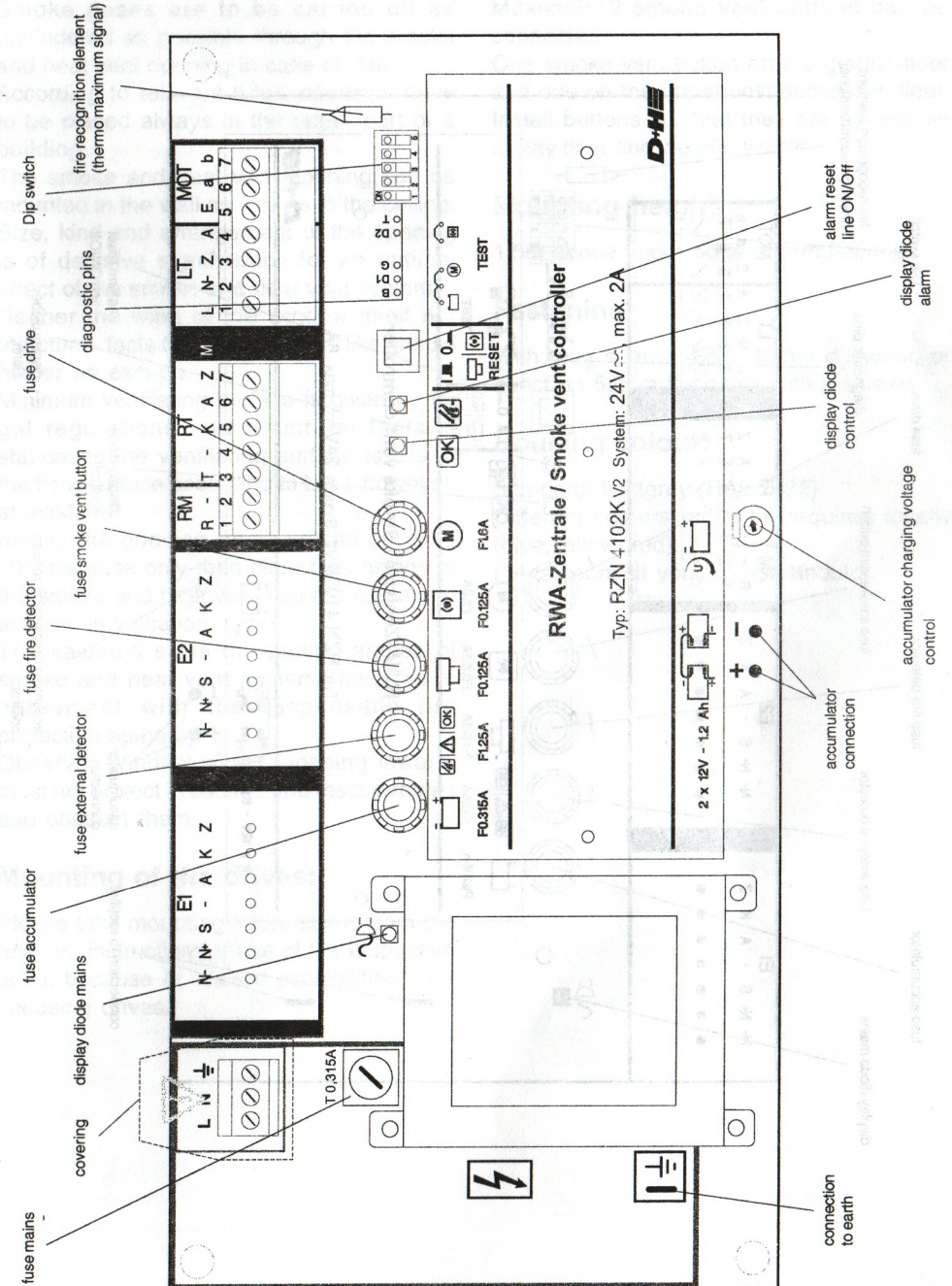

View Motherboard RZN 4108-K V2

Mount control cabinet sheltered and easily accessible for maintenance in proximity of drive

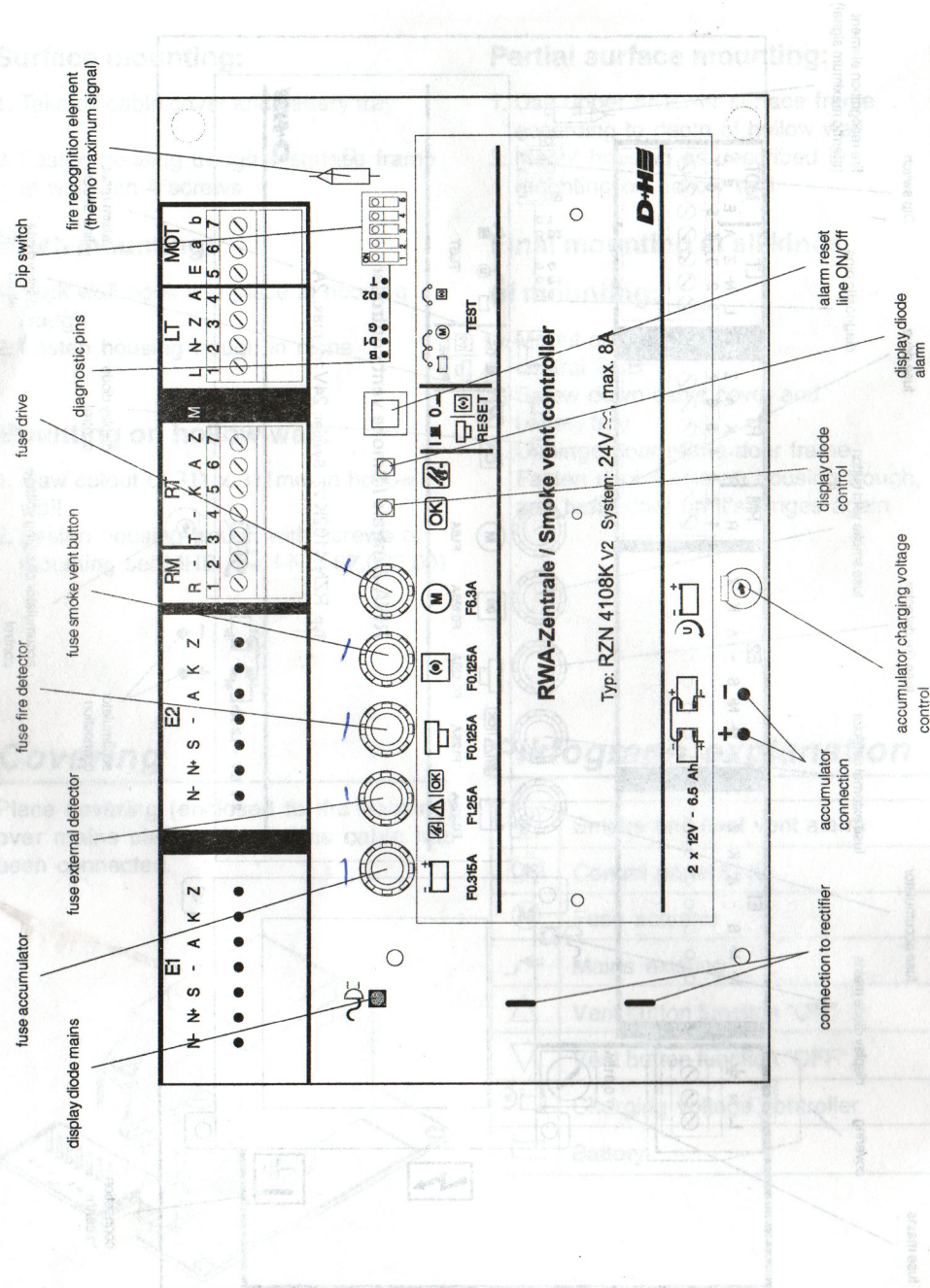

Drives

Smoke and heat vent opening:

Smoke gases are to be carried off as unhindered as possible through the smoke and heat vent opening in case of fire. According to relevant rules, openings have to be placed always in the upper part of a building.

The smoke and heat vent opening can be mounted in the wall as well as in the ceiling. Size, kind and arrangement of the opening is of decisive significance for an optimal effect of the smoke and heat vent system. Neither the wing of the window itself nor structural facts like offsets or the like should hinder an escape.

Minimum ventilating surface is given by legal regulations and structural facts. In staircases the ventilating surface is 5% of the floor surface according to LBO, however, at least 1m².

Ideally the opening angle should be circa 70°, because only then clear dimensions of the smoke and heat vent flap are taken into account in valuation.

The valuated sizes of opening angles of smoke and heat vent systems must be in agreement with the responsible fire protection authority.

Observe! Window wings, opening inward, must not project in escape and rescue routes and obstruct them.

Mounting of the drives:

Please take mounting informations from the relevant instruction for use of the respective drive, because of varied possibilities for choosing drives.

Smoke Vent Button

Place(s) of mounting:

Maximal 12 smoke vent buttons can be connected.

One smoke vent button on the ground-floor and one on the uppermost accessible floor. Install buttons so, that they are accessible at any time and clearly visible.

Mounting height:

1,5m above upper edge of firm flooring.

Fastening:

With plug screws 4,5 x 40mm diagonal, or direct on 55mm flush box with 2 screws.

Housing colour:

Standard: lightgrey (RAL 7035)
Different colours might be required locally (blue, yellow, red).
Please consult your D+H distributor.

Wiring Plan (Paragon)

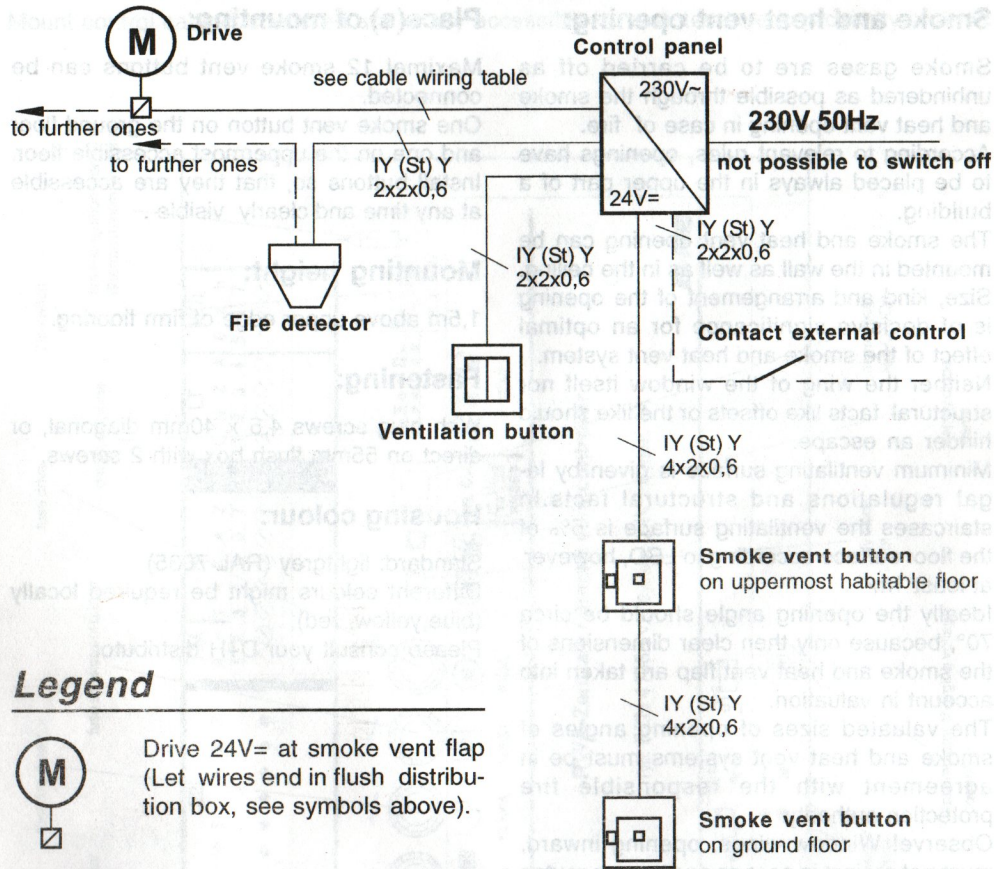

Legend



Drive 24V= at smoke vent flap (Let wires end in flush distribution box, see symbols above).

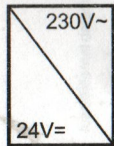

RZN surface or flush type (230V~/24V=) in proximity of smoke vent flap.



Smoke vent button (e.g. RT42) surface 24V= circa 1,5m above upper edge firm flooring (by customer 55mm flush socket)



Vent button 24V= (e.g. LT43) circa 1,2 above upper edge firm flooring (at flush type by customer 55mm flush socket)



Fire detector 24V= (e.g. FO 1362 or FT 1262)

230 V Supply

Provide for separate electric circuit. Mark fuses. Plug covering cap over mains binder on motherboard of control panel. Connecting cable: NYM-13x1.5
Connecting load: RZN 4102-K(S) = 60 VA
RZN 4108-K = 240 VA

Weak Current Lines

Install and feed separately from supply mains. Mark cable and binder socket red.

Cable for D+H Smoke and Heat Vent Systems

The smoke vent control panel is designed for opening smoke vent devices, which operate by thermal ascending force and by automatic fire recognition devices (thermal detector, smoke detector), and they release either self-acting or manual by smoke buttons at an early stage of a fire, and remain in the opened position without further power consumption. In these cases, functioning preservation of the electrical line system is required at an early stage of fire only. Protected wiring is required with protection from mechanical damages according to DIN 18232 section 2.5.5 paragraph 4.

Control Cable (Group):

Cable from the smoke vent control panel to connection of drive (drive lines have a monitoring wire, in which fire recognition devices (thermal maximal detector e.g. THE) can be looped-in):
- Safety line, with functioning preservation ... E30, according to DIN 4102*

Detector Cables (Line):

The detector cables are monitored for short circuit and for break. The opening device is automatically triggered and opens up in case of fault, when DIP-switch 2 is on ON. Smoke vent button cable and cable of automatic detectors:
- weak current sheathed flexible cable YR 6 x 0.8
or
- house wiring cable IY(ST)Y 4 x 2 x 0.6

Cables through areas not monitored:

An increased time of functioning of the cable can be required, when drive lines are installed through building parts, which are not monitored.
- Safety line with functioning preservation ... E90, according to DIN 4102*

(see supplementary sheet 1 to DIN VDE 0108)

* Notice: No type designation is given for these cables, because of the big variety on the market. Please consult your D+H distributor about these.

Line lengths and Cross sections:

Earthed conductor must not be wired!

Typ / type	RZN 4108-K																
	RZN 4102-K(S)				5	6	7	8	9	10	11	12	13	14	15	16	
Antriebe / drives	0,5A	1	2	3	4	5	6	7	8	9	10	11	12	13	14	15	16
	1A		1	2	3	4	5	6	7	8	9	10	11	12	13	14	15
	3x 1,5mm ²	240	120	80	60	48	40	34	30	26	24	21	20	18	17	16	15
	3x 2,5mm ²	400	200	130	100	80	65	55	50	44	40	36	33	30	28	26	25
*	5x 2,5mm ²	800	400	260	200	160	130	110	100	88	80	70	65	60	56	52	50
**	7x 2,5mm ²	1200	600	390	300	240	200	170	150	130	120	110	100	92	85	80	75

cross section (mm²) = $\frac{\text{plain cable length (m)} \times \text{number of drives}}{80^{***}}$

* Connect in parallel 2 wires for each drive line.

** Connect in parallel 3 wires for each drive line.

*** Only valid for drives with 1A drive current. Use drive current „160“ for drives with 0,5A.

Standard Connection

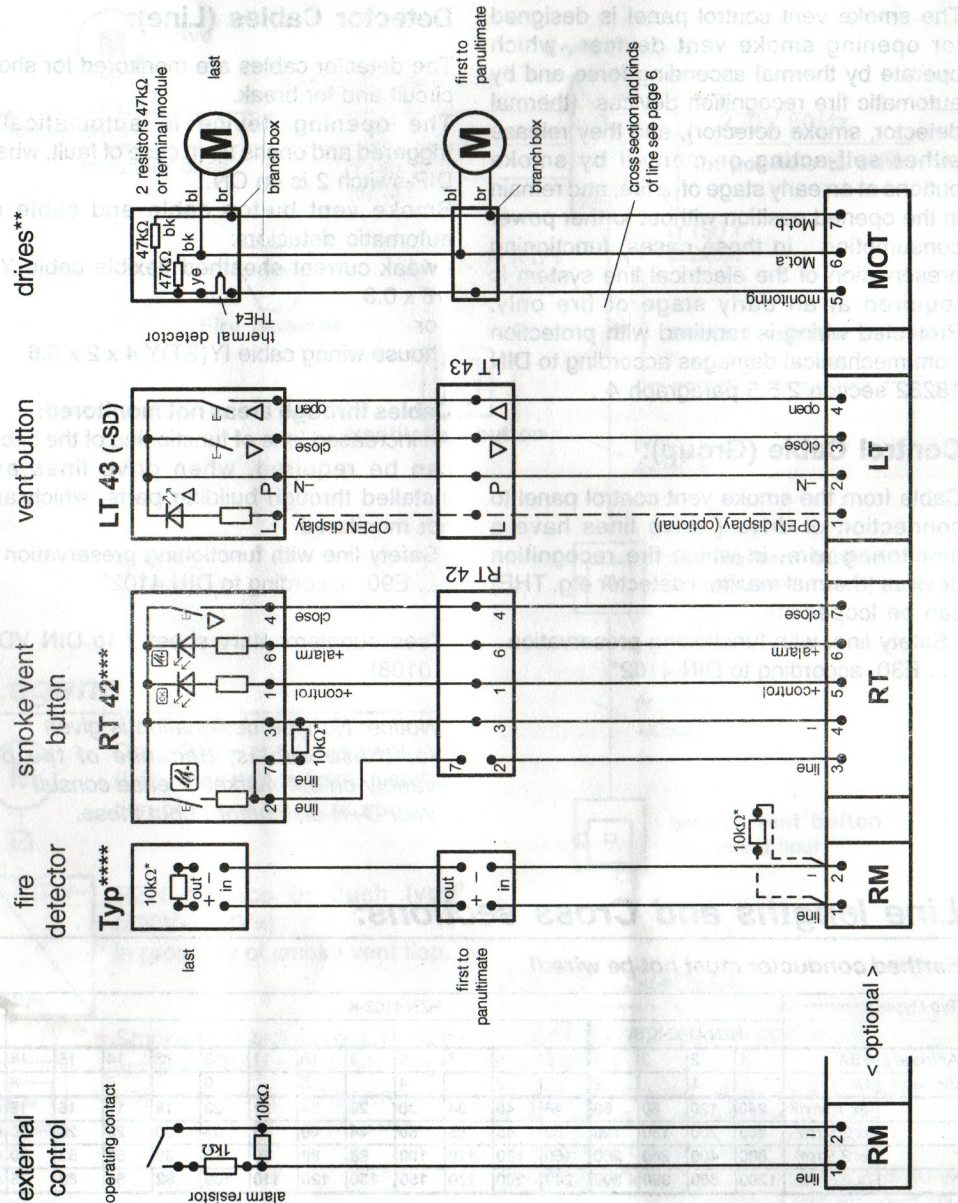

*** Terminal resistors for line monitoring:**
 They are pinched in control panel for transport. Take it off there and connect according to plan. Terminal resistors must remain at binder RM 1,2, when no fire detector or external control exists.

**** Maximal number of drives:**
 RZN 4102K = 2 drives with each 1 A
 RZN 4108K = 8 drives with each 1 A
 When drives with 0.5 A drive current, double number of drives required.
 1 A less, when alarm devices are connected!

Parallel Connection of Smoke Vent Buttons

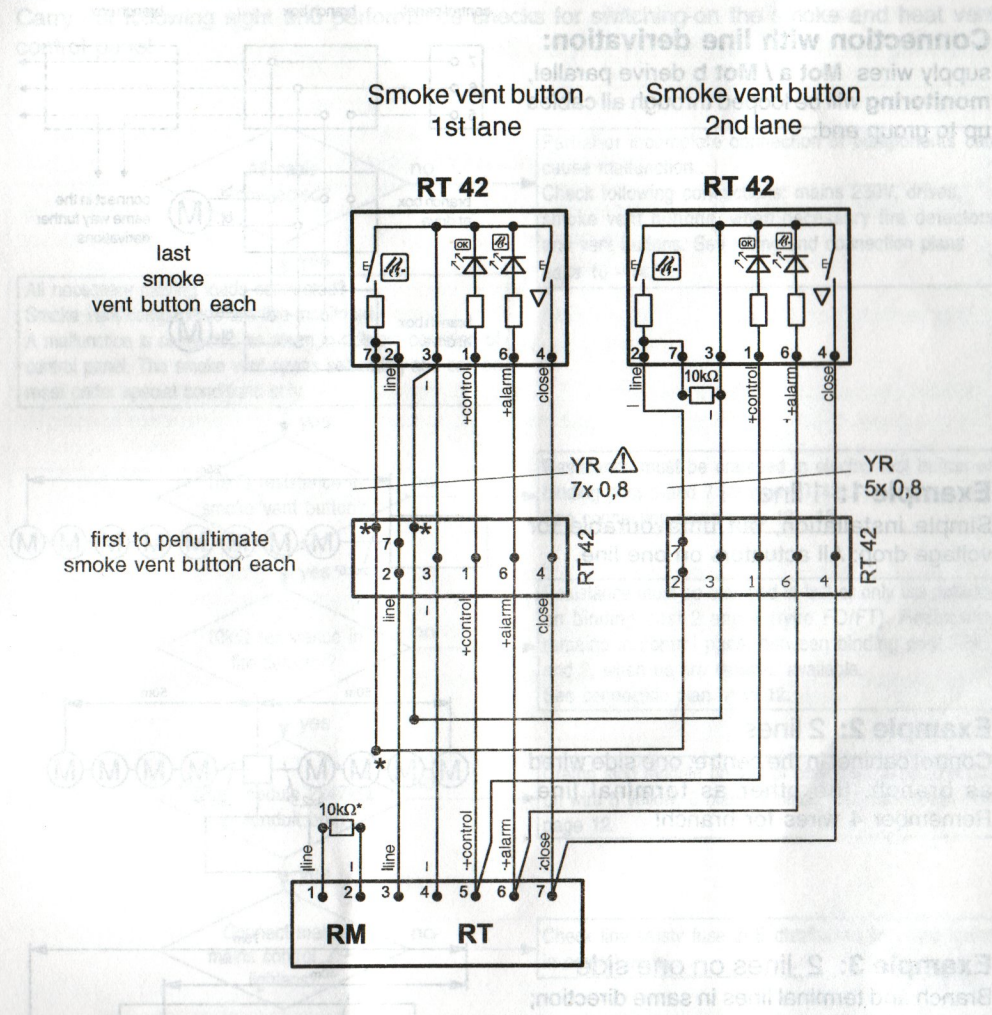

***** Smoke vent button RT 42**
 With smoke vent buttons with a lower plate number than DH4642 (see reverse of plate), exit of line to next smoke vent button from **terminal 2**. Terminal 7 is without function.

****** Fire detector**
 Only D+H system approved detectors are allowed to use.

* Shunt connection by customer

Connection Examples

Connection with line derivation:
supply wires Mot a / Mot b derive parallel, monitoring will be looped through all cables up to group end.

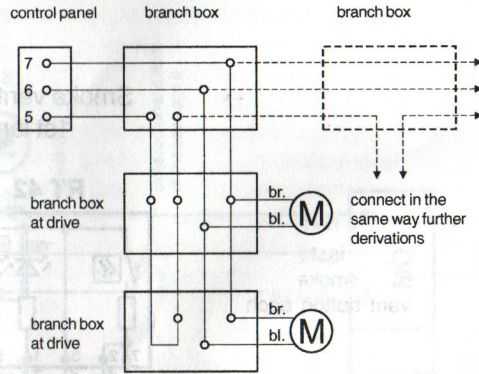

Example 1: 1 line

Simple installation, but unfavourable for voltage drop: All actuators on one line.

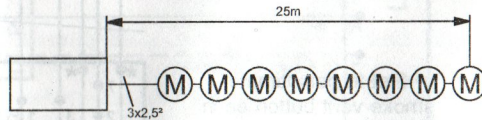

Example 2: 2 lines

Control cabinet in the centre, one side wired as branch, the other as terminal line. Remember 4 wires for branch!

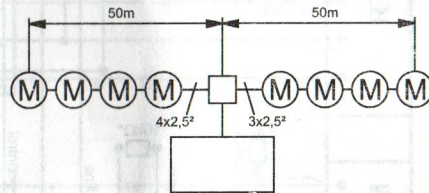

Example 3: 2 lines on one side

Branch and terminal lines in same direction; number of actuators vary according to length of line. Remember 4 wires for branch!

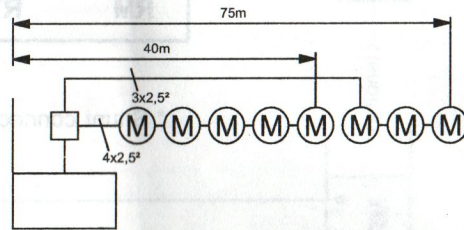

Example 4: 3 lines

Due to extremely long distances, 3 lines are installed: 2 lines, each with 3 actuators over 75 m as branch line, and 1 line with 2 actuators over 200 m. Remember 4 wires for branch!

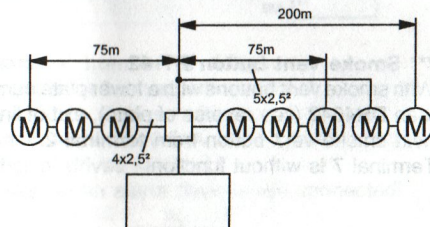

Informations for Starting

Carry out following sight and performance checks for switching-on the smoke and heat vent control panel.

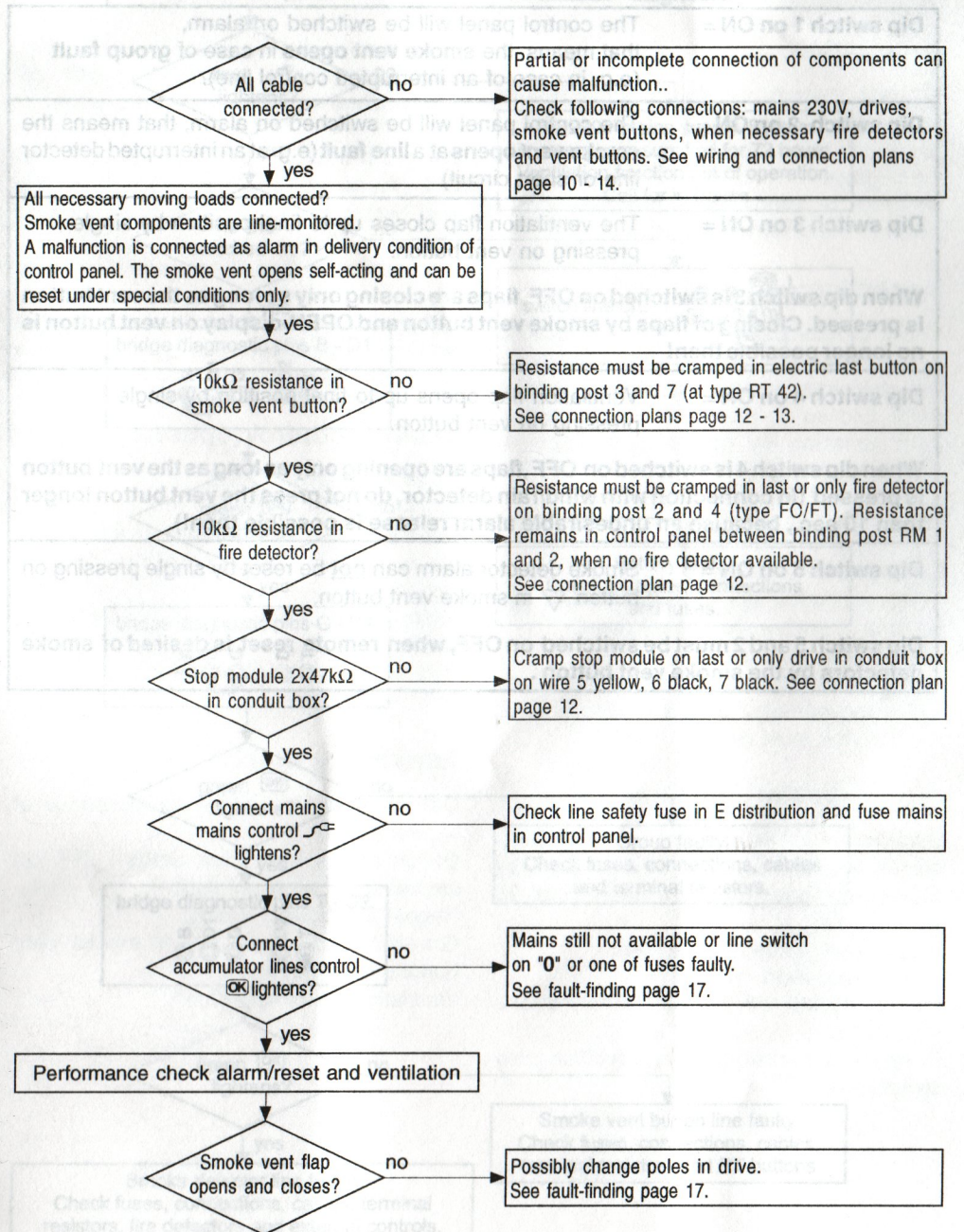

Encode of Line and Group

Following functionings can be set with Dip switch on motherboard .

Dip switch 1 on ON =	The control panel will be switched on alarm, that means, the smoke vent opens in case of group fault (e.g. in case of an interrupted control line).
Dip switch 2 on ON =	The control panel will be switched on alarm, that means the smoke vent opens at a line fault (e.g. at an interrupted detector line or short circuit).
Dip switch 3 on ON =	The ventilation flap closes up to final position by single pressing on vent button.
When dip switch 3 is switched on OFF, flaps are closing only so long as the vent button is pressed. Closing of flaps by smoke vent button and OPEN-display on vent button is no longer possible then!	
Dip switch 4 on ON =	Ventilation flap opens up to final position by single pressing on vent button.
When dip switch 4 is switched on OFF, flaps are opening only as long as the vent button is pressed (In connection with wind/rain detector, do not press the vent button longer than 10 sec., because an undesirable alarm release is possible then!).	
Dip switch 5 on ON =	Smoke detector alarm can not be reset by single pressing on button ▽ in smoke vent button.
Dip switch 5 and 2 must be switched on OFF, when remote reset is desired of smoke detectors by the smoke vent button .	

Fault Finding

green  in smoke vent button does not lighten



Faults detected must be repaired before continuing with diagnosis!

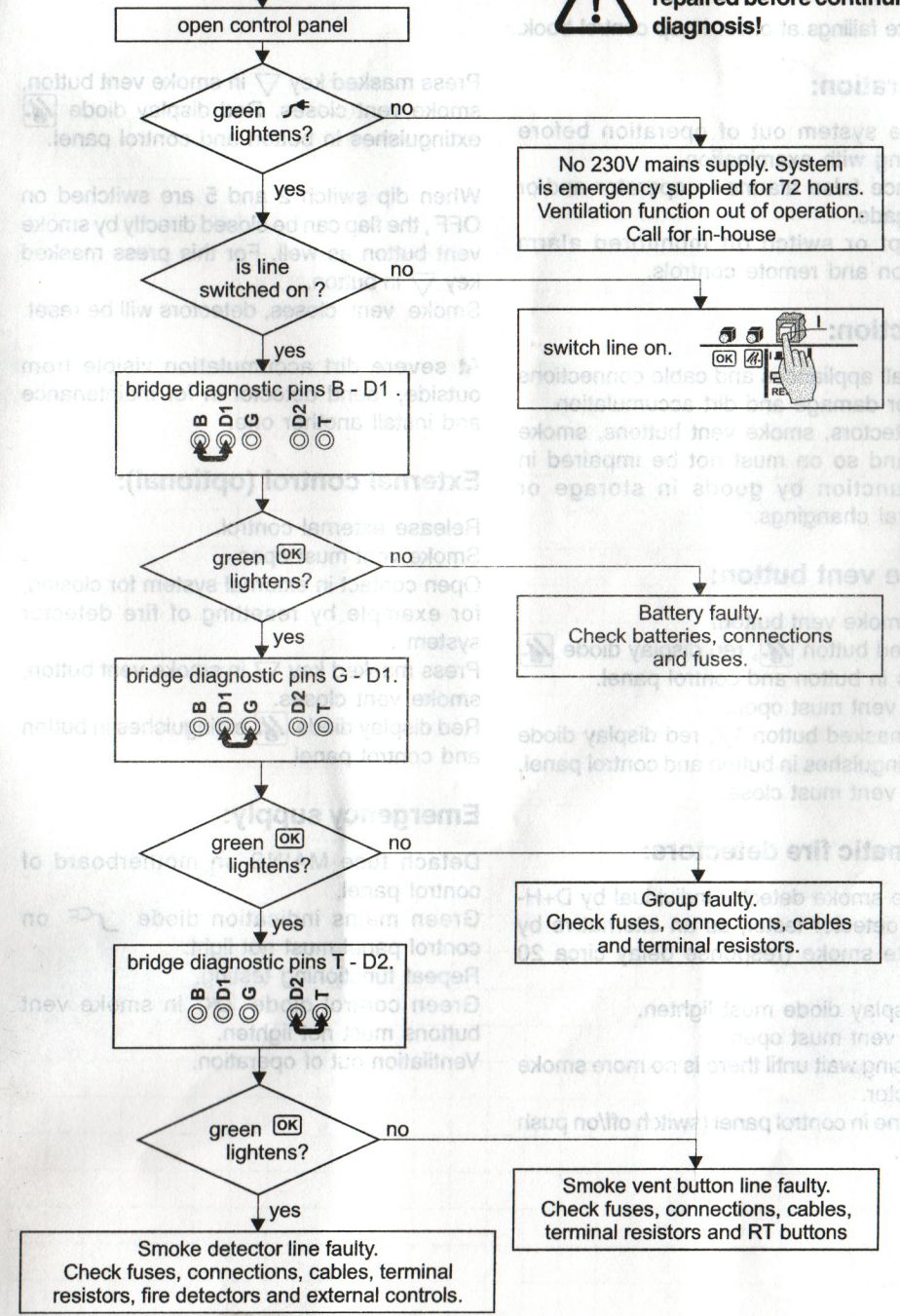

Examination

Every six months and after repair by a specialist or staff, who has been introduced to the task.

Eliminate failings at once. Keep control book.

Preparation:

Indicate system out of operation before beginning with examination.

Announce false alarms to operator and/or fire brigade.

Interrupt or switch off monitored alarm indication and remote controls.



Inspection:

Check all appliances and cable connections for outer damage and dirt accumulation.



Fire detectors, smoke vent buttons, smoke vents and so on must not be impaired in their function by goods in storage or structural changings.

Smoke vent button:

Open smoke vent button.

Press red button , red display diode  lightens in button and control panel.

Smoke vent must open.

Press masked button , red display diode  extinguishes in button and control panel.

Smoke vent must close.

Automatic fire detectors:



Release smoke detector individual by D+H-smoke detector tester, as an alternative by cigarette smoke (response delay circa 20 sec.).

Red display diode must lighten.

Smoke vent must open.

For closing wait until there is no more smoke in detector.

Reset line in control panel (switch off/on push switch).

Press masked key  in smoke vent button, smoke vent closes. Red display diode  extinguishes in button and control panel.

When dip switch 2 and 5 are switched on OFF, the flap can be closed directly by smoke vent button as well. For this press masked key  in button.

Smoke vent closes, detectors will be reset.

At severe dirt accumulation visible from outside, send detector in for maintenance and install another one.

External control (optional):

Release external control.

Smoke vent must open.

Open contact in external system for closing, for example by resetting of fire detector system.

Press masked key  in smoke vent button, smoke vent closes.

Red display diode  extinguishes in button and control panel.

Emergency supply:

Detach fuse MAINS on motherboard of control panel.

Green mains indication diode  on control panel must not light.

Repeat functioning testing.

Green control diode  in smoke vent buttons must not lighten.

Ventilation out of operation.

Notes

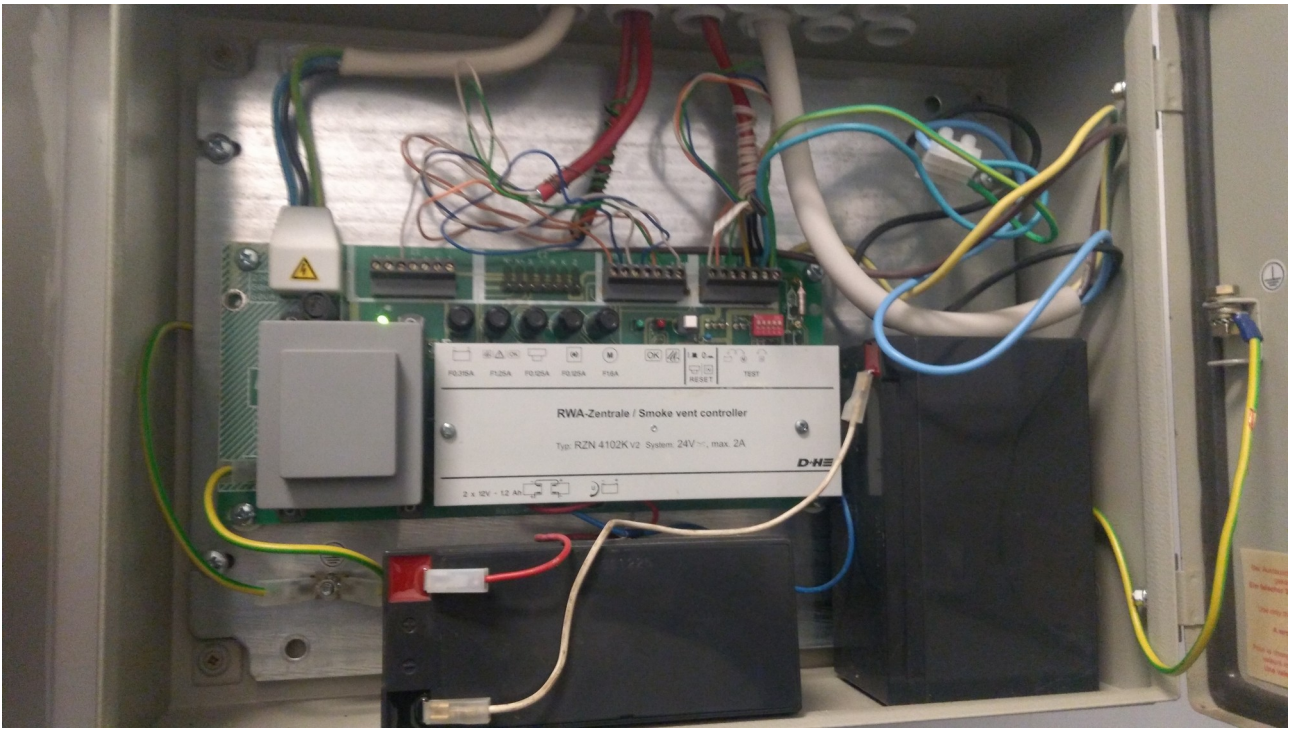

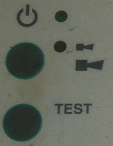

SIGMA

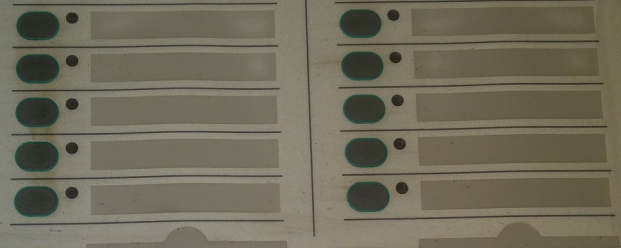

- Sieć
- Głośność
- TEST** Sprawdzenie lampki sygnalizacyjnej i sygnalizatora dźwiękowego
- Lampka sygnalizacyjna strefy i przycisk kasujący

TRYB ALARMOWY
 Wykasa lampka sygnalizacyjna strefy

KASOWANIE
 Naciśnięcie przycisku kasujący strefy na panelu spowoduje wyłączenie sygnalizatora dźwiękowego. Lampka sygnalizacyjna strefy nie będzie świecić. Aby ponownie wykasować nadzwonej po za pomocą przycisku kasującego strefy, należy nacisnąć przycisk alarmu po uprzednim użyciu przycisku alarmu.

UWAGA
 Panel można również tak skonfigurować, aby było możliwe kasowanie go za pomocą przycisku kasującego znajdującego się na panelu.
 Naciśnięcie tego przycisku spowoduje wyłączenie sygnalizatora dźwiękowego i wygaszenie blyskającej lampki (jeżeli w czasie instalacji została ustawiona przyciskowa powrotna alarmu).
 Lampki także możliwości konfiguracji panela w taki sposób, aby sygnalizator dźwiękowy i lampka wygaszały się automatycznie, po użyciu przycisku alarmu.
DALSZE INFORMACJE ZNAJDUJĄ SIĘ W INSTRUKCJI OBSŁUGI